



### Application area

- General process technology
- Food industry
- Pharmaceutical industry
- Biotechnology

### Technical data

#### Constructional design / case

Design:	High quality case with bajonet ring, material: stainless steel mat.-no. 1.4301 (304)
Nominal size:	NS 100 or NS 160
Degree of protection per EN 60529:	IP 66

### Features

- Gas expansion thermometer for dead-zone free measurement in pipes
- The whole inner surface of the pipe wall works as temperature transducer
- Piggable and suitable for CIP-cleaning
- High quality case with bajonet ring NS 100/160, degree of protection IP 66
- Nominal ranges -40 °C...250 °C
- Case, measuring system and temperature transducer of stainless steel
- Accuracy class 1 per EN 13190 when insulated in the plant
- Micro adjusting pointer for indication correction
- Immersion lengths are the same as at LABOM diaphragm seals, see product group D5
- EAC declaration (upon request)

### Options

- Approvals/Certificates
  - Explosion protection (ATEX) for mechanical devices
  - Certificate of measuring equipment for Russian Federation
  - Material certificate per EN 10204
  - Calibration certificate per EN 10204
- Case with liquid filling
- Electronical angle-of-rotation sensor, Type series PL1100, see data sheet D6-020
- Wetted parts electropolished

### Application

Mechanical inline thermometers allow dead-zone free measuring of the pipe wall temperature. Measuring is performed without cross-sectional alterations. The lower the medium viscosity, the higher the measurement accuracy. The whole inner surface of the pipe wall works as temperature detecting element. The instrument becomes an integrated part of the pipeline. Various pipe connection elements are available. During CIP procedures the nominal range should not be exceeded.

Case filling:	Labofin Further filling liquids upon request.
Case seal:	Material gasket: NBR
Window:	Non-splintering laminated glass. Option: Non-splintering plastic (Macrolon)
Movement:	Stainless steel with compensation

Scale:	Pure aluminium, white with black inscription. Alternatively with marking or fixed reference pointer.
Pointer:	Pure aluminium, black with micro adjustment for zero point correction

### Process connection

Design:	Threated or clamp as part of piping, Connections and nominal widths see order details. Material: stainless steel mat.-no. 1.4404 (316L) Further process connections upon request. An insulation in plant of the measuring point is recommended.
Pressure stage:	See tables below dimensions.

### Measuring element

Measuring element:	Bourdon tube, dead zone free with noble gas filling.
--------------------	--

### Nominal range

Nominal range (EN 13190):	-40...250 °C. Measuring span $\geq$ 60 °C. Alternatively extension of measuring range to the complete nominal range. (Please not CIP cleaning temperature)
---------------------------	---

See order details, further upon request.



### Accuracy

Accuracy class:	1.0 per EN 13190
-----------------	------------------

### Temperature ranges

Ambient:	Per EN 13190. Ambient temperatures that deviate from EN are to be specified.
Storage and transport:	-20...60 °C Further temperature ranges upon request.

### Tests and certificates

Explosion protection:	Ex- protection (ATEX) for mechanical devices  II 2G c TX  II 2D c TX
-----------------------	--

Further details and temperature limits see Ex Instruction XA\_005.

- EAC declaration (upon request)
- Certificate of measuring equipment for Russian Federation

### Instructions for use

The loading capacity of the temperature detecting element depends on the following parameters:

- Media
- Media pressure
- Media temperature
- Flow velocity
- Insertion length
- Material

A technical examination might be necessary.

**Information on other models see order details or upon request.**

Further information to mounting and operation see Operating Instruction BA\_017.

# Dimensions

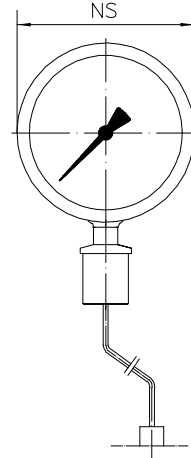
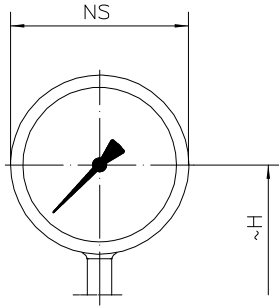

	H	H from 160°
NS 100	96	136
NS 160	126	166

Threaded pipe connection per DIN 11851 or DIN 11864-1

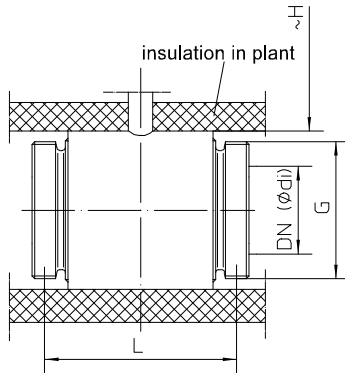

**Dimensions / Threaded pipe connections per DIN 11851 or DIN 11864-1**

DN	di	PN <sup>1</sup>	G	L
10	10	40	Rd. 28x1/8	110
15	16	40	Rd. 34x1/8	110
20	20	40	Rd. 44x1/6	110
25	26	40	Rd. 52x1/6	110
32	32	40	Rd. 58x1/6	110
40	38	40	Rd. 65x1/6	110
50	50	25	Rd. 78x1/6	110
65	66	25	Rd. 95x1/6	110
80	81	25	Rd. 110x1/4	60
100	100	25	Rd. 130x1/4	60
125	125	16	Rd. 160x1/4	60

IDF connection per ISO 2853

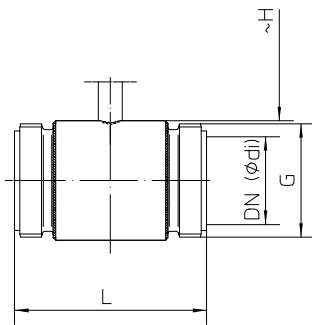

**Dimensions / IDF- thread per ISO 2853**

DN		PN <sup>1</sup>	di	G	L
1"	25	40	22.6	TR37x3.175	110
1 1/2"	38	40	35.6	TR50.5x3.175	110
2"	51	25	48.6	TR64x3.175	110

<sup>1</sup> Media temperature up to 140 °C

Clamp connection per ISO 2852, DIN 32676 or DIN 11864-3

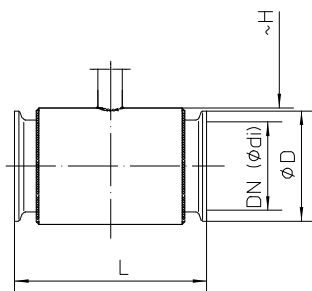

**Dimensions / clamp-connection per ISO 2852, DIN 32676 or DIN 11864-3**

DN		PN <sup>2</sup>	di	D	L
1"	25	16	22,6	50,5	110
1 1/2"	38	16	35,6	50,5	110
2"	51	16	48,6	64	110

<sup>2</sup> Media temperature up to 120 °C

## Order details

### Gas expansion thermometer with inline detecting element

#### Type series FS....

Order details FS....					
FS2400	case design degree of protection IP 66	inline detecting element	NS 100	without liquid filling	
FS3400			NS 160		
FS2600			NS 100	with liquid filling	
FS3600			NS 160		
		nominal range	measuring range		
A2340	standard ranges [°C], accuracy class 1 per EN 13190 <sup>1</sup>	-20...40	-10...30		
A2346		-20...60	-10...50		
A2322		-30...50	-20...40		
A2220		-40...40	-30...30		
A2222		-40...60	-30...50		
A2520		0...60	10...50		
A2522		0...80	10...70		
A2524		0...100	10...90		
A2540		0...120	20...100		
A2544		0...160	20...140		
A2548		0...200	20...180		
A2560		0...250	30...220		
H1104		inline detecting element <sup>2</sup>	threaded pipe connection per DIN 11851 (both sides)	DN 10	
H1106	DN 10				
H1108	DN 20				
H1110	DN 25				
H1120	DN 32				
H1130	DN 40				
H1140	DN 50				
H1150	DN 65				
H1160	DN 80				
H1170	DN 100				
H1180	DN 125				
H4110	threaded couplings per IDF ISO 2853 (both sides)			1"	
H4130				1 1/2"	
H4140				2"	
H3210	clamp connection per ISO 2852 (both sides)		1"		
H3230			1 1/2"		
H3240			2"		
H6104-P1001	aseptic design per DIN 11864-1 model A		DN 10		
H6106-P1001			DN 15		
H6108-P1001			DN 20		
H6110-P1001			DN 25		
H6120-P1001			DN 32		
H6130-P1001			DN 40		
H6140-P1001			DN 50		
H6150-P1001			DN 65		
H6160-P1001			DN 80		
H6170-P1001			DN 100		

Additional features (to be indicated in case of need, only)		
S30	Ex-protection (ATEX) mechanical devices <sup>3</sup>	⊕ II 2G c TX
		⊕ II 2D c TX
R13	window	macrolon with adjustable reference pointer <sup>4</sup>
T2	marking	on scale (please specify)
T3		fixed reference pointer (please specify)
W1020	material certificate	per EN 10204-3.1, wetted parts
W1204	calibration certificate	per EN 10204-3.1, 3 measuring points
W1201		per EN 10204-3.1, 5 measuring points
W2673	certificate of measuring equipment for Russian Federation	
W4035	electropolishing of wetted parts <sup>4</sup>	

Order code (example): FS2400 - A2524 - H1104 - ...

<sup>1</sup> accuracy class 1 with adequate insulation in plant

<sup>2</sup> further pipe dimensions upon request

<sup>3</sup> within the temperature limits according to Ex instruction XA\_005

<sup>4</sup> not for devices with Ex-protection